

Annex – 15.0

Agenda Item # 15.0

“Start up power requirement of under construction NCC PPL Power Plant”

1	NCCPPL letter dated 17.11.2014	2 Pages
2	NCCPPL presentation	7 Pages
3	Transmission Agreement	4 Pages
4	MoP letter	1 Page
5	Arrangement	2 Pages
6	Consent letter between TPCIL and NCC	1 Page



NCC Power Projects Limited
CIN: U40102AP2008PLC059628
Site Office: Anathavaram Village,
Varakavipudi Panchayat,
Thotapalli Gudur Mandal,
SPSR Nellore - 524344

NCCPPL/COM-PGCIL/14-15/49

17th November 2014

To,

Shri. Ms. Seema Guptha
Chief Operating Officer (CTU)
Power grid Corporation of India Limited,
SAUDAMINI, Plot No-2, Sector-29
Gurgaon, Haryana- 122 001
Tel 0124-2571306 Fax- 0124-2571762

Sub: Standing Committee proposal – NCC's Temporary Loop In & Loop out (LILO ~0.75 km) of the existing TPCIL to Nellore PS 400kV D/C evacuation line to cater the Start-Up Power requirement of under construction NCC PPL (2X660MW) Power Plant.

Dear Madam,

Sembcorp Utilities Pte.Ltd, Singapore (FDI in India) in JV with Gayatri Group/NCC Infra, Hyderabad is developing two coastal based coal fired supercritical power stations in Nellore, AP - Thermal Powertech Corporation India Ltd (TPCIL) and NCC Power Projects Ltd. (NCCPPL) each of 2x660MW, totalling 2640 MW. The plants are geographically located adjacent to each other with a common boundary wall.

TPCIL project is in advance stage of construction and expected to commission in Dec'14 for which the evacuation system (TPCIL-Nellore 400kV D/C line) was built and commissioned by PGCIL in Aug'13. NCC Power project limited is also progressing well and is expected to commission in CY Q4 2015.

In June 2012, NCC PPL signed the LTOA &TA with PGCIL for its evacuation requirements and subsequently MoP advised PGCIL to build the dedicated line (NCC PPL-Nellore 400kV D/C) on cost plus basis. With the project expected to commission by end 2015, we requested PGCIL for early commissioning of the line, and accordingly a supplementary agreement was signed in May'14 with PGCIL giving the best efforts commissioning schedule of Dec'15 (enclosed).

We understand that PGCIL has already awarded the contract for execution of the said line and we appreciate the efforts made by PGCIL to push its contractors for achieving the best efforts commissioning schedule of the line (by Dec'15). However, as per NCCPPL's project schedule, back charging of 400KV switchyard is expected in May'2015 to meet the plant commissioning and testing activities (Start-up power requirement). This would result in mismatch of ~6 months due to non-availability of the line from May'2015, which may hamper the commissioning activities of the project.

Accordingly, to meet the startup power requirements of the project, we propose to construct temporary LILO on one of the existing TPCIL to Nellore PS 400kV D/C line at NCC PPL bus bar. Since the projects are geographically adjacent, the proposed LILO length would be only be ~0.75 km. Also, since both the plants are being built by the same promoters, the proposal has been jointly prepared by NCC PPL & TPCIL and officially an NOC has also been obtained from TPCIL. (TPCIL NOC letter enclosed).

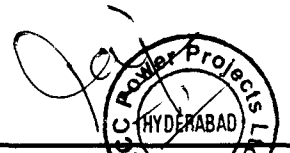



NCC Power Projects Limited
CIN: U40102AP2008PLC059628
Site Office: Anathavaram Village,
Varakavipudi Panchayat,
Thotapalli Gudur Mandal,
SPSR Nellore - 524344

Further, to expedite the development of LILO proposal and seeking regulatory approvals from CEA/CTU/RPC/LDC, we initiated discussions with all the agencies and based on the detailed discussions, we have broadly outlined the LILO proposal on the following key points:

1. NCC PPL to construct at its own expense the proposed temporary Loop in Loop out (LILO) portion of the transmission system (in compliance with CEA technical standards and IEGC for constructing & maintaining the lines) and will NOT request for any tariffs from CERC.
2. NCC PPL to bear the resultant transmission losses due to construction of LILO portion and will adhere to instructions of SRLDC/SRPC for all day to day activities.
3. NCC PPL to utilize the LILO arrangement for its start-up power requirements (from May'2015 onwards) and post commissioning of PGCIL dedicated line of NCC PPL to Nellore PS 400kV D/C, the LILO will be disconnected.
4. NCC PPL agrees to transfer the ownership of the LILO to M/s PGCIL, if required (under regulations/as advised by Standing Committee),

Note: Detailed proposal along with relevant documents enclosed as annexure.

We request PGCIL/CEA to favourably consider and table NCC PPL's proposal for the proposed temporary LILO arrangements in upcoming Standing Committee Meeting which will help the project achieve timely COD.

Yours Sincerely,

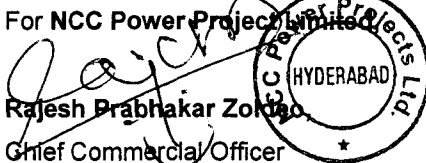
For NCC Power Projects Limited

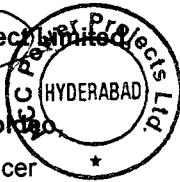
Rajesh Prabhakar Zorbo
Chief Commercial Officer



Copy to: 1. Member Powers system, CEA
2. Member Secretary, SRPC.
3. ED, SRLDC
4. Director, Power System, CEA

Encl: 1. Detailed LILO proposal
2. Supplementary Transmission Agreement
3. Topo sheet and block diagram
3. TPCIL no objection letter for LILOing the TPCIL-NPS 400kV D/C at NCC PPL.



NCC Power Projects Limited

2x660MW Coastal based Coal Fired Supercritical Power Station, Nellore, AP

Proposal for temporary LILO
of existing 400kV D/C line for Startup Power



Encl-1

- Sembcorp Utilities Pte. Ltd, Singapore (FDI in India) in JV with Gayatri Group/NCC Infra, Hyderabad is developing two coastal based coal fired supercritical power stations in Nellore, AP - Thermal Powertech Corporation India Ltd (TPCIL) and NCC Power Projects Ltd. (NCCPPL) each of 2x660MW, totaling 2640 MW. The plants are geographically located adjacent to each other with a common boundary wall.
- TPCIL project is in advance stage of construction and expected to commission in Dec'14 for which the evacuation system (TPCIL-Nellore 400kV D/C line) was built and commissioned by PGCIL in Aug'13.
- NCC PPL is expected to commission by Dec'2015 and further from May'2015 onwards it requires startup power for commencing its commissioning and testing activities.
- Evacuation and Grid connectivity arrangements:
 - NCC PPL has been granted connectivity of 1240 MW to central transmission utility of PGCIL via agreement dated 04 June 2012.
 - NCC PPL has signed Transmission Agreement (TA) and Long Term Access Agreement for 740MW with PGCIL on 28th June 2012. Additionally, on 21st May 2014 NCC PPL signed supplementary transmission agreement with PGCIL for early commission of the dedicated transmission system, (best efforts by Dec'2015).
- Considering the mismatch (~6 months) in the startup power requirement from May'2015 and planned Grid Connection availability from Dec'2015, we propose to construct temporary LILO on one of the existing TPCIL to Nellore PS 400kV D/C line at NCC PPL bus bar.

Details of the Proposal - Cost & Ownership

- **Common promoters:** Since both the plants are being built by the same promoters, the proposal has been jointly prepared by NCC & TPCIL and an official NOC has also been obtained from TPCIL.
- **Geographical proximity:** The projects are geographically adjacent, thus the proposed LILO length (additional) would only be ~0.75 km (proposed survey topo sheet enclosed herewith).
- **Cost of the System:** NCC PPL to construct this LILO portion of Transmission system on its own cost and will NOT request for any tariffs from CERC. Further, NCC PPL will ensure compliance to CEA technical standards for constructing this LILO portion of the Transmission system.
- **Ownership:** NCC PPL to maintain the proposed Transmission system as per the CEA connectivity standards/IEGC and if required, will transfer the ownership of the LILO to M/s PGCIL (as per regulations/Standing Committee advise).

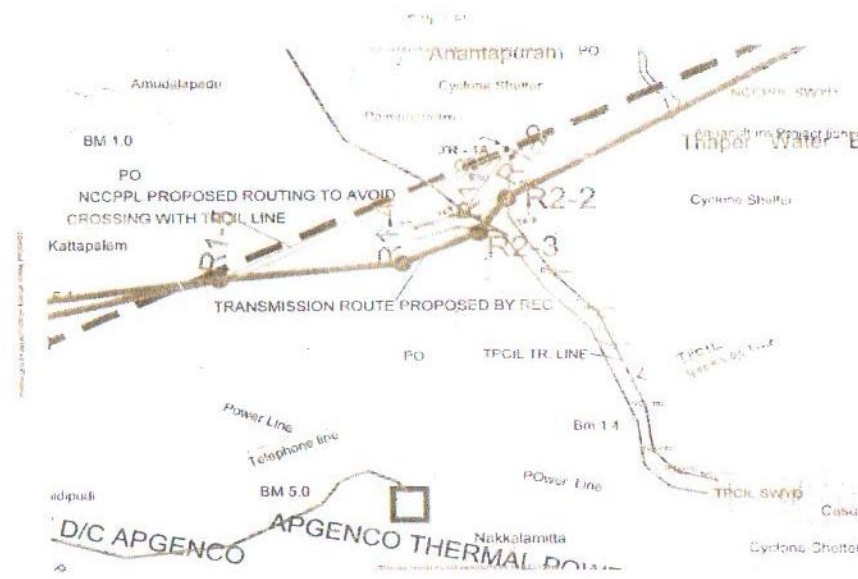
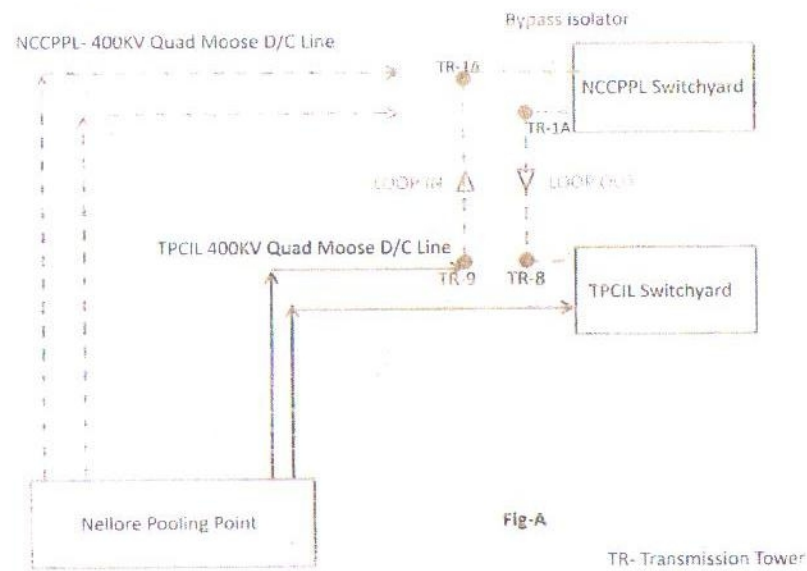

Details of the Proposal - Energy accounting & Losses



- **Energy Accounting:** NCC PPL proposed to LILO one of the TPCIL to Nellore PS 400kV D/C line at NCC PPL bus bar and metering arrangements are depicted in the below figure.
- **Losses:** NCC PPL to absorb the dedicated line loss of the additional length of LILO (0.75 km). NCC PPL will detail the modus operandi in consultation with SRPC/SRLDC for all Billing/Losses related issues.
- **Startup power:** Payment of the energy consumption charges (drawal of startup power) will be borne as per regulations viz. deviation mechanism.

Billing on NCC PPL Account: “Actual Energy consumption + Dedicated line losses evaluated”

- Actual Energy consumption calculation: = C1 meter data – C2 meter data
- Dedicated line losses evaluation

Pictorial Representation of the NCC PPL LILO arrangement and Energy Consumption Accounting:

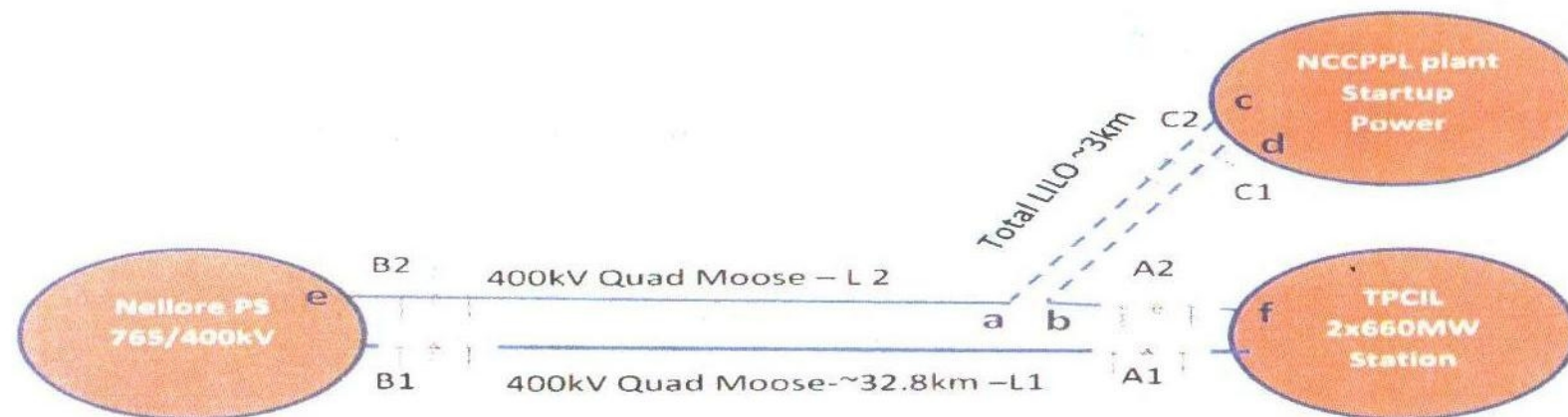

Details of the Proposal – Utilization of power (startup power only)



- **Utilization of LILO** - NCC PPL to utilize the proposed LILO arrangement for availing startup power only. Post commissioning of dedicated line of NCC PPL to Nellore PS 400kV D/C (expected Dec'15) LILO will be disconnected.
- NCC PPL at all times will adhere to instructions given by the SRLDC/concerned authority.

Conclusion & Approval Sought



Based on detailed discussions with PGCIL/CEA/SRPC/SRLDC, LILO proposal has been outlined on the following key points:

1. NCC PPL to construct at its own expense the proposed temporary Loop in Loop out (LILO) portion of the transmission system (in compliance with CEA technical standards and IEGC for constructing & maintaining the lines) and will NOT request for any tariffs from CERC.
2. NCC PPL to bear the resultant transmission losses due to construction of LILO portion and will adhere to instructions of SRLDC/SRPC for all day to day activities.
3. NCC PPL to utilize the LILO arrangement for its start-up power requirements (from May'2015 onwards) and post commissioning of PGCIL dedicated line of NCC PPL to Nellore PS 400kV D/C, the LILO will be disconnected.
4. NCC PPL agrees to transfer the ownership of the LILO to M/s PGCIL, if required (under regulations/as advised by Standing Committee).

Approval Sought

We request PGCIL/CEA to favorably consider and table NCC PPL's proposal for the proposed temporary LILO arrangements in upcoming Standing Committee Meeting which will help the project achieve timely COD.

Thank You



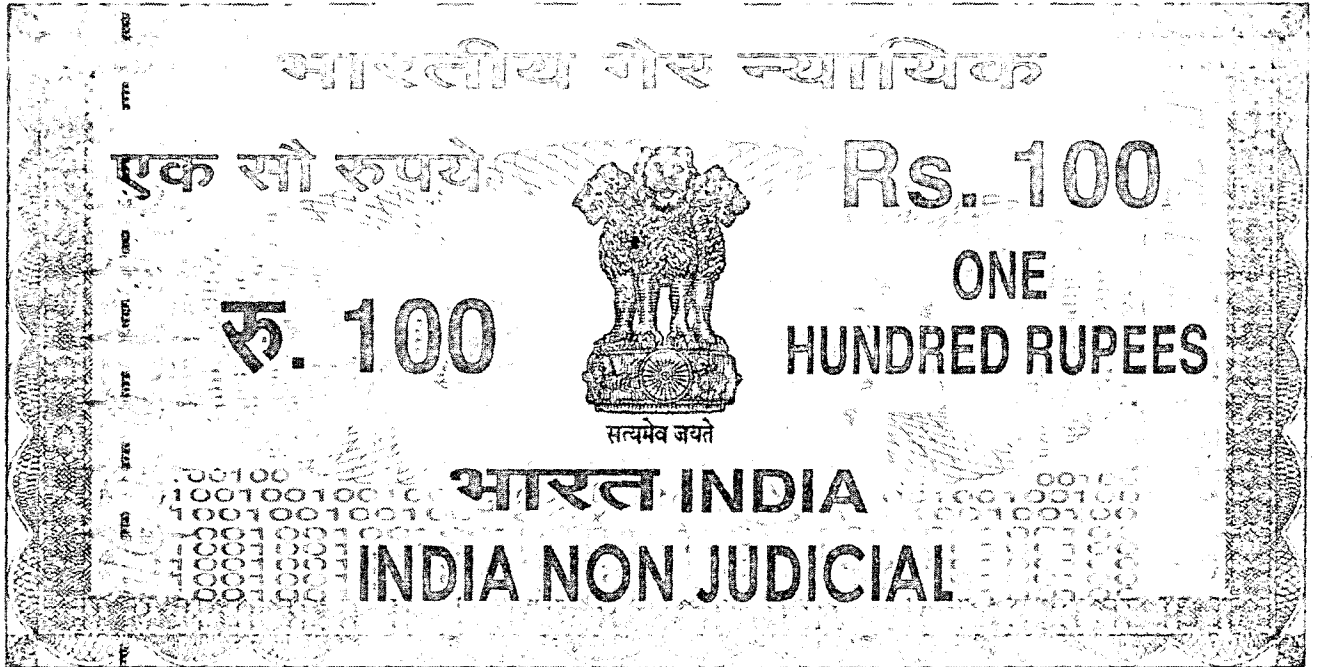

हरियाणा HARYANA SUPPLEMENTARY TRANSMISSION AGREEMENT
 BETWEEN
 POWER GRID CORPORATION OF INDIA LIMITED
 AND
 NCC POWER PROJECTS LTD.

M 316370

THIS SUPPLEMENTARY TRANSMISSION AGREEMENT made on this 21st day of May, 2014

BETWEEN

POWERGRID CORPORATION OF INDIA LIMITED, incorporated under the Companies Act, 1956, having its registered office at B-9, Qutab Institutional Area, Katwaria Sarai, New Delhi-110 016 (hereinafter called "POWERGRID" which expression shall unless repugnant to the context or meaning thereof include its successors and assigns) as party of the first part;
AND

NCC POWER PROJECTS Ltd., incorporated under the Companies Act, 1956 having its registered office at 6-3-1090, Block A, Level-5, TSR Towers, Rajbhavan Road, Somajiguda, Hyderabad – 500 082 (herein after called "NCC Power" specifically and "Long term transmission Customer or LTC" generally which expression shall unless repugnant to the context or meaning thereof include its successors and assigns) as party of the second part;

(Long Term Transmission Customer and POWERGRID are hereinafter individually referred to as 'Party' and collectively as 'Parties')

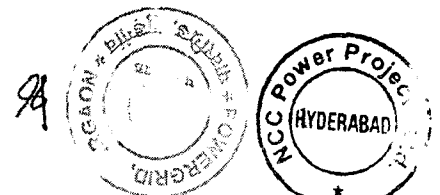
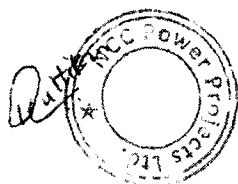

AND WHEREAS NCC Power is a Generating Company and has been granted Long Term Access for 740 MW by CTU vide LTA grant intimation letter no. C/ENG/SEF/TA/L/S/12/016 dated 4th June, 2012 and connectivity for 1240 MW vide their intimation letter no C/SEF/TA/C/S/12/24 dated 4th June, 2012 in accordance with Central Electricity Regulatory Commission (Grant of Connectivity, Long-term Access and Medium-term Open Access in inter-State Transmission and related matters) Regulation, 2009 and Electricity Act, 2003 to the Inter State Transmission System.

AND WHEREAS NCC POWER and POWERGRID have entered into a Transmission Agreement for Connectivity on 28th June, 2012 and a Long Term Access Agreement on 28th June 2012 for evacuation and dispatch of power to beneficiaries in Southern Region from power project near Nellore, Andhra Pradesh. .

AND WHEREAS as per the Long Term Access Agreement dated 28th June, 2012 the following Evacuation Transmission System is required to facilitate evacuation of power:

- a) 1x125 MVAR Bus Reactor at Generation Switchyard
- b) Two nos. of 400 kV bays at NCC Power generation switchyard
- c) NCC Power – Nellore Pooling Station 400 kV Quad D/c line
- d) Two nos. of 400 kV bays Nellore Pooling station of POWERGRID.

AND WHEREAS the evacuation transmission system mentioned at a) & b) shall be built, owned, operated and maintained by NCC POWER and Item d) shall be implemented by POWERGRID as per the Transmission Agreement signed on 28.06.2012 . However, Item c), which was to be implemented through Tariff Based Competitive Bidding(TBCB) as per the aforementioned Agreement, shall now be implemented by POWERGRID as per the directives of Ministry of Power, Govt of India, (MoP, GoI) issued vide their letter no. 15/9/2013-Trans dated 10th December, 2013 (Copy enclosed at **Annexure-A**).

AND WHEREAS for the said open access, NCC POWER shall inject power at Nellore Pooling station to be executed by POWERGRID.

AND WHEREAS POWERGRID has informed that keeping into consideration the timeline for the transmission project based on the activities involved, the schedule for commissioning of c) & d) shall be Dec, 2016.

AND WHEREAS as per the assessment carried out by Joint Co-ordination Committee, first Unit (2* 660 MW) of NCC Power may be commissioned by December, 2015 as also confirmed by NCC Power. To facilitate evacuation of power, the connectivity transmission system for NCC Power mentioned at Item c)

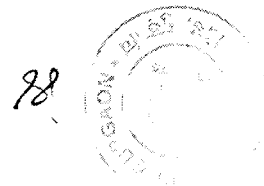
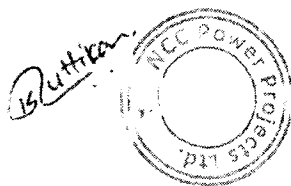

and d) above shall be required to be commissioned earlier than the above schedules indicated by POWERGRID.

AND WHEREAS NCC Power has requested POWERGRID to take up the action for execution of c) & d) above so as to facilitate evacuation of Power from their First unit from December, 2015.

AND WHEREAS POWERGRID informed that they shall make best efforts to commission the above mentioned elements under c) & d) by December, 2015 for facilitating evacuation of Power from 1st unit of generation Plant of NCC Power.

AND Whereas NCC POWER has agreed to pay in full, the transmission charges including any other charges to POWERGRID from the date of commissioning of c) & d), indicated above, irrespective of the Commissioning of the 1st unit of NCC Power, till the Transmission System becomes part of ISTS network and covered in PoC i.e COD of 1st Generating unit of NCC Power.

NOW, THEREFORE, in consideration of the premises, mutual agreements, covenants and conditions set forth in this Agreement and other Agreements referred above, which shall form an integral part of this Agreement, it is hereby agreed by the parties as follows:-

- A. NCC POWER shall bear and pay the full transmission charges to POWERGRID as determined by CERC, for the transmission system from the date of commissioning of Transmission System till date of commercial operation (COD) of 1st Generating Unit of NCC Power.
- B. NCC POWER shall also pay other applicable charges to POWERGRID including FERV, Income Tax, Incentive and any other charges in accordance with the CERC Regulations in force.
- C. NCC Power shall open an irrevocable, revolving LC equivalent to 210 % of estimated monthly transmission charges as Payment Security Mechanism, two months prior to the commissioning of above transmission system, as per the information to be furnished by POWERGRID.
- D. This payment security mechanism shall initially remain valid for twelve months and shall be renewed from time to time as per the requirement.

E. Default on account of breach of Agreement

In case NCC Power does not furnish or fails to furnish the Letter of Credit of requisite amount and other Payment Security Mechanism in

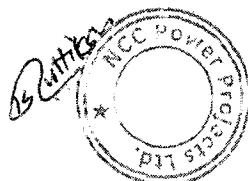

accordance with CERC Regulations, the same shall constitute to be a Breach of Contract or Default of LTA and would entitle CTU to foreclose and terminate the LTA Agreement after giving 30 days notice of default to NCC Power.

NCC Power may choose to remedy the default by furnishing Letter of Credit and other Payment Security Mechanism to CTU within such notice period, failing which the LTA Agreement and consequent the LTA shall be cancelled by CTU.

F. POWERGRID also reserves the right to encash Construction Bank Guarantee(CBG) furnished by NCC Power, in case of their failure to make payment against transmission Charges or to establish LC towards Payment Security Mechanism of requisite amount.

G. This agreement shall not modify or alter any of the covenants agreed to by and between the parties vide the LTA agreement and Transmission Agreement both dated 28th June 2012, except for the changes brought out above, but shall be conterminous with the said agreement.

IN WITNESS WHEREOF the parties have executed this Agreement through their authorized representatives at Gurgaon on the day, month and year mentioned above.

1.

Witness

Signature: Jasbir Singh
 Name: जसबीर सिंह
Jasbir Singh
 Designation: उप महानिदेशक (आवक)

For and on behalf of
POWER GRID CORPORATION OF INDIA LTD.

Signature: Seema Gupta
 Name: सोना गुप्ता / SEEMA GUPTA
महानिदेशक (आवक) / General Manager (A/C)
ED. आर. वि. वि. / Commercial
 Designation: पावर ग्रिड कॉर्पोरेशन ऑफ इंडिया लि.
Power Grid Corporation of India Ltd.
संस्थान का स्थान / (A Govt. of India Enterprise)
प्लॉट नं-2, सेक्टर-29, गुरुगंज-122 001 (हरियाणा)
Plot No.2, Sector-29, Gurgaon-122 001 (HARYANA)

2.

Witness

Signature: P. R. Bhat
 Name: P. R. BHAT GUJRAL
 Designation: A.C.M.

For and on behalf of
NCC Power Projects Ltd.

Signature: Kedar Guttikar
 Name: KEDAR GUTTIKAR
 Designation: MANAGER (COMMERCIAL)
NCC POWER PROJECTS LTD.

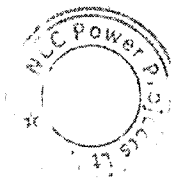

Annexure A

No. 15/9/2013-Trans
Government of India
Ministry of Power
Sharam Shakti Bhawan, Rafi Marg, New Delhi

Dated, the 10th December, 2013

OFFICE MEMORANDUM

Subject:- Transmission System for Connectivity for NCC Power Projects Limited (1320 MW) to be taken up under compressed time schedule through regulated tariff mechanism route.

Ref:- CEA letter No. 100/11/REC-10/2013-SP&PA/1806-08 dated 15.10.2013.

The undersigned is directed to inform that the Minister of State in Ministry of Power (IC) has approved the following transmission scheme including its scope for implementation by Power Grid Corporation of India Limited (CTU) under compressed time schedule through regulated tariff mechanism.

Name of the Scheme: Transmission System for Connectivity for NCC Power Projects Limited (1320 MW).

Scope of the scheme: NCC Generation Switchyard - Nellore Pooling Station 400 kV D/C (Quad) line.

2. It is requested that necessary action may kindly be taken accordingly.

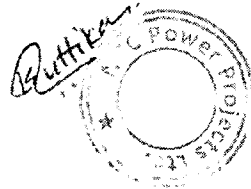



(S.Venkateshwarlu)
Under Secretary (Trans)
Tele.No.2332 5242
Email:transdesk-mop@nic.in

To

Chairperson,
Central Electricity Authority,
Sewa Bhawan, R.K.Puram,
New Delhi-110066

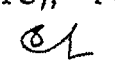
Copy forwarded to Shri Y.K. Sehgal, COO (CTU), PGCIL, Guargaon, for information and necessary action.

(S.Venkateshwarlu)
Under Secretary (Trans)

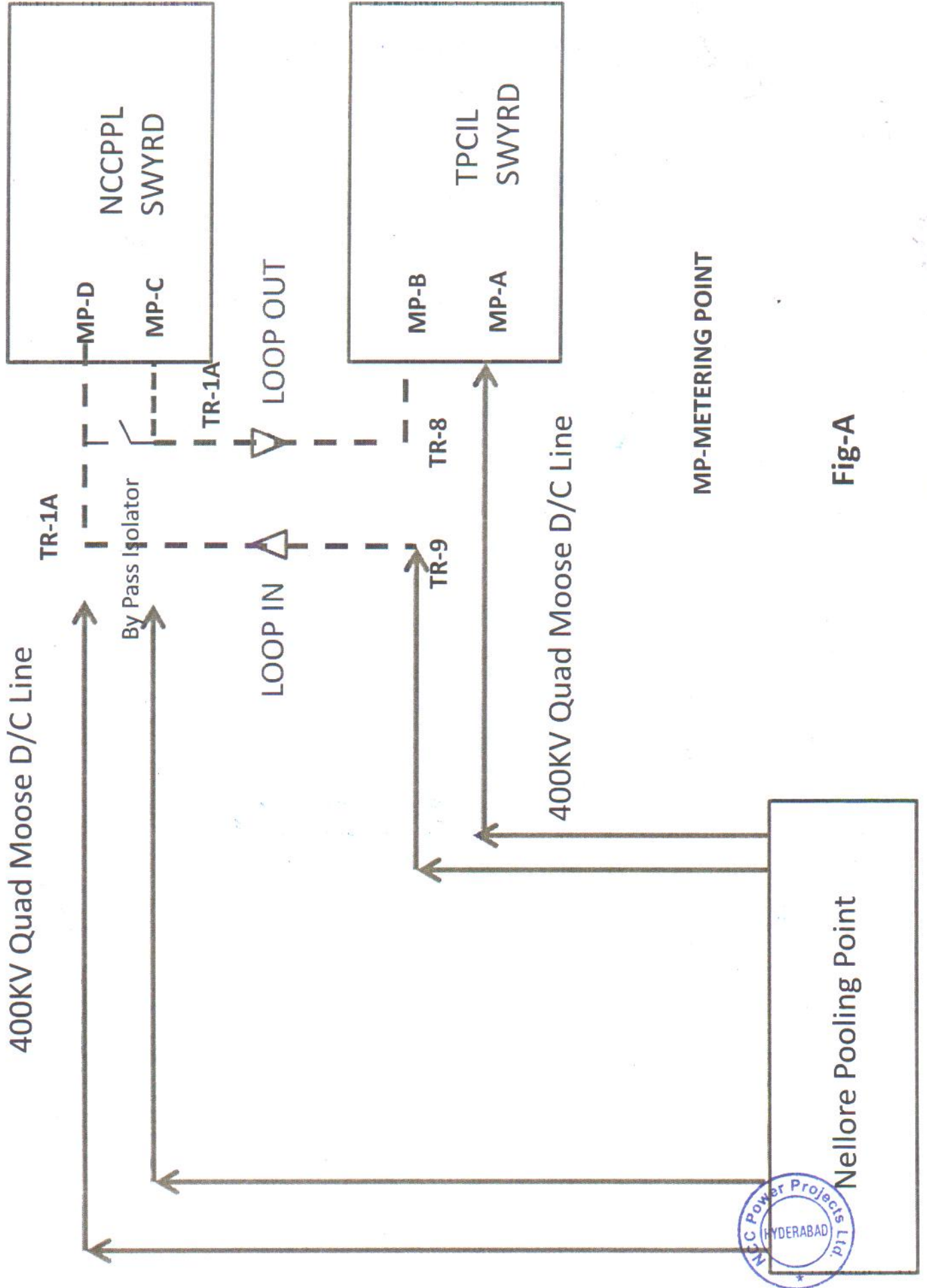

Fig-A



Thermal Powertech Corporation India Ltd
 6-3-1090, 2nd Floor, C-Block
 TSR Towers, Rajbhavan Road, Somajiguda
 Hyderabad 500082, Andhra Pradesh, India
 Tel (91) 40 4904 8300 / 2331 0350
 Fax (91) 40 2337 0360
 www.tpcil.com

September 24, 2013

No. TPCIL/Com-NCC/13-14/42

To,
 CEO,
 NCC Power Projects Ltd.,
 NCC House, Madhapur,
 Hyderabad – 500 081,
 Andhra Pradesh, India.

Sub: Consent letter for proposed LILO arrangement between TPCIL & NCC

Dear Sir,

In reference to letter no. NCCPL/PGCIL-SRPC/09//2013/001 dated 02/09/13 and subsequent discussions, NCC has requested TPCIL's consent for constructing LILO at TPCIL-Nellore line. As per our understanding and in line with REC tender documents for construction of transmission system for NCC, the evacuation system via NCC-Nellore 400kV D/C line is expected to be ready by April 2015, whereas the startup power for NCC will be required by August 2014, thereby creating a mismatch of almost 8 months. To cater to this interim requirement, NCC has proposed a temporary LILO at existing TPCIL-Nellore line.

In view of the above mentioned request, TPCIL gives in-principle approval for implementing LILO proposal subject to the following:

1. Technical proposal/scheme to be approved by SRLDC/SRPC/CEA, PGCIL and CERC.
2. TPCIL's board approval on commercial proposal for sharing of losses, charges etc.
3. NCC to ensure the temporary arrangement will not have any adverse effect on TPCIL's evacuation.

With this consent, NCC may initiate discussions at various forums to obtain clarity on technical and regulatory issues and finalization of LILO scheme. Post finalization, TPCIL to give final consent subject to board approval.

We request NCC to keep TPCIL in loop for any discussions on the subject matter with concerned authorities to ensure TPCIL management is updated at all times.

We assure TPCIL team will extend its full support to help NCC find an amicable solution.

Thanking you,

Yours faithfully,
 For Thermal Powertech Corporation India Ltd

 Atul Nargund
 CEO

